

2-INCH W X 20-INCH D X 20-INCH H TRADITIONAL BRACKET

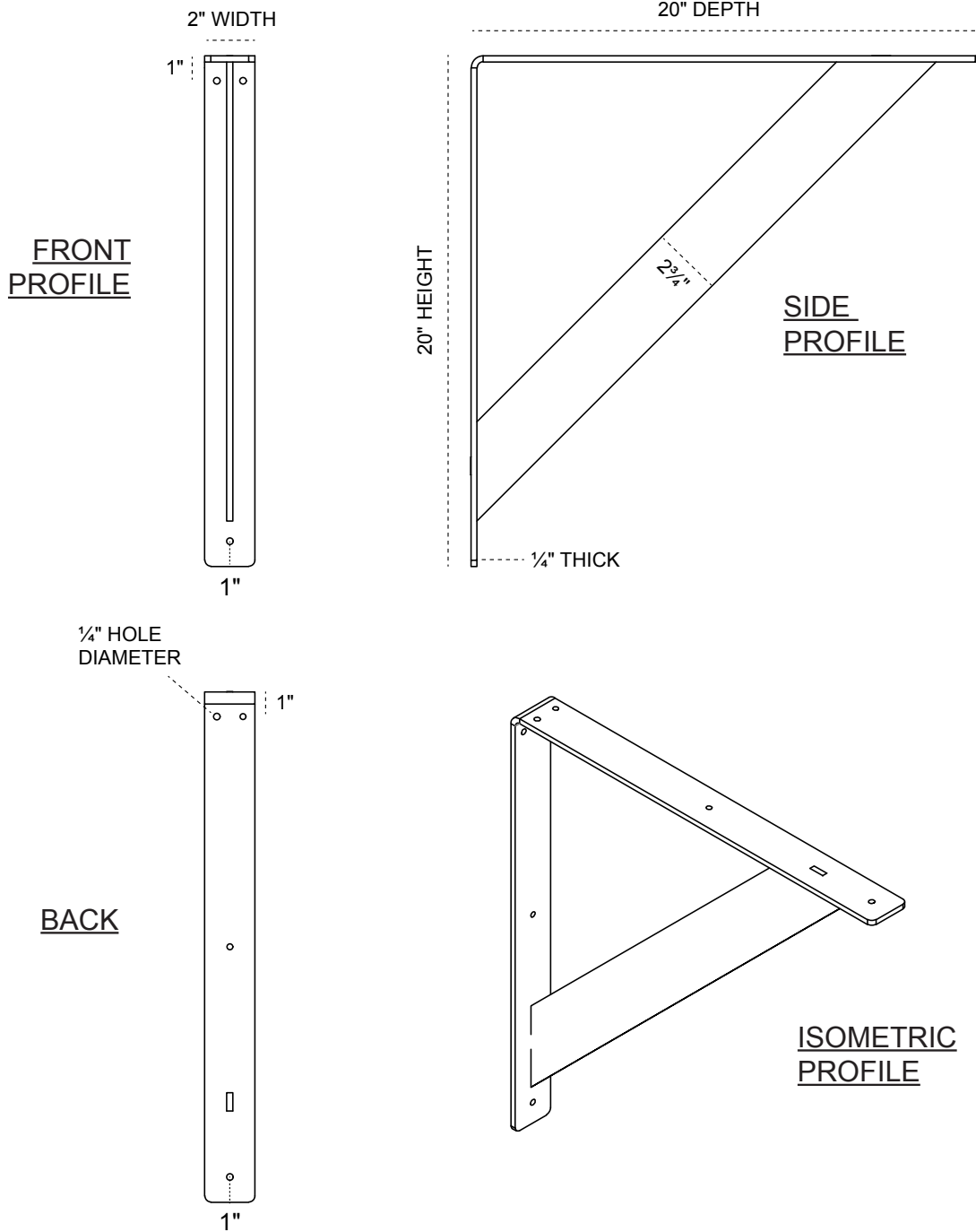

HEAVY-DUTY 1/4" THICK

AVAILABLE IN:
STAINLESS STEEL
ZINC PLATED STEEL
POWDER COATED BLACK

BKTM02X20X20TRSS
BKTM02X20X20TRCRS
BKTM02X20X20TRPBL

P:866.607.0453 | F: 866.591.3143
2300 W. Main St. | Clarksville, TX 75426
sales@ekenamillwork.com | www.ekenamillwork.com



EKENA
MILLWORK